



wedi®

# Range Of Products



40 37276 102839



# Contents

<b>wedi building boards</b>	<b>5</b>
Building board	5
BA Vapor	5
BA Construct	6
Building board accessories	7 - 8
BA Balco	9
BA Balco sloping board	9
BA Balco stepboard	9
BA Balco accessories	9
<b>wedi building board systems</b>	<b>10</b>
wedi pipe covering box	10
Bath/shower panel	10
Bathbox	10
wedibloc	10
wedibloc accessories	10
<b>wedi Fundo and accessories</b>	<b>12</b>
Fundo scope of delivery	12
Fundo floor level shower element	13
Fundo quarter circle	13
Fundo custom made	14
Fundo kit spiral	15
Fundo kit round	15
Fundo kit pentagon	15
Fundo VBK – spiral and round	16
Fundo Phanos	17
Fundo Tulipano	17
Fundo Labirinto	17
Fundo Rosa	17
Fundo genuine glass door round	18
Fundo sliding glass door	18
Fundo Easy Set subconstruction	18
Fundo accessories	18 - 19
Fundo technical advice	20
<b>wedi products for spas and leisure centers</b>	<b>21</b>
Sanoasa seats	21
Sanoasa loungers	22
Sanoasa accessories	22
Sanoasa Home no. 1-6 (technology has to be installed on site)	23 - 25
Sanoasa Home no. 7-10 (technology pre-installed)	26 - 29
Sanoasa technical advice	30
<b>wedi Sanbath – tileable bath furniture</b>	<b>31</b>
Sanbath Wave	31
Sanbath Flat	31
Sanbath Cube	32
<b>Impact sound deadening boards</b>	<b>33</b>
Nonstep	33
<b>wedi accessory products</b>	<b>33</b>
Jolly-Color	33
Protective covering fabric	33
<b>wedi PVC profiles</b>	<b>34</b>
Jolly-profile	34
R-profile	34
<b>wedi movement and expansion joints</b>	<b>34</b>
Triolos expansion joint profile	34
Expansion joint profile for thin-bed tiling	34
Expansion joint profile for thick-bed tiling	34
<b>wedi metal profiles</b>	<b>35</b>
Step A.S.S.	35
Brass profile	35
Aluminium profile	35
Stainless steel V <sub>4</sub> A profile	36
Stainless steel edge protection profile	36
VIP-profile / VIP-corner	36
Combi-profile	36
PRO Balco	37

For information, brochures and prices,  
please contact our sales department in  
Emsdetten

**Telephone: +49 2572 156-0**

**Fax: +49 2572 156-133**

## ***Products made to specification***

---

For special products, i. e. partition  
systems, products for spas and leisure  
centres and floor level shower elements  
with special sizes, please contact  
our technical department.

**Telephone: +49 2572 156-0**

**Fax: +49 2572 156-239**

# wedi building boards

## wedi building boards

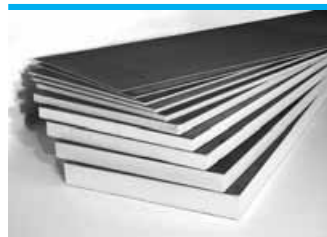

Order no.	Description	Dimensions length x width x thickness	Packing unit/ pallet
01-00-00/004	building board	1250 x 600 x 4 mm	136 boards = 102 m <sup>2</sup>
01-00-00/006	building board	1250 x 600 x 6 mm	136 boards = 102 m <sup>2</sup>
01-07-00/010	building board	1250 x 600 x 10 mm	100 boards = 75 m <sup>2</sup>
01-00-00/010	building board	2500 x 600 x 10 mm	50 boards = 75 m <sup>2</sup>
01-00-00/112	building board	<b>new</b> 2500 x 600 x 12.5 mm	50 boards = 75 m <sup>2</sup>
01-00-00/012	building board	2500 x 625 x 12.5 mm	50 boards = 78.13 m <sup>2</sup>
01-00-00/020	building board	2500 x 600 x 20 mm	50 boards = 75 m <sup>2</sup>
01-00-00/030	building board	2500 x 600 x 30 mm	36 boards = 54 m <sup>2</sup>
01-00-00/040	building board	2500 x 600 x 40 mm	36 boards = 54 m <sup>2</sup>
01-00-00/050	building board	2500 x 600 x 50 mm	24 boards = 36 m <sup>2</sup>
01-07-10/060	building board	2500 x 600 x 60 mm	24 boards = 36 m <sup>2</sup>
01-07-10/080	building board	2500 x 600 x 80 mm	20 boards = 30 m <sup>2</sup>
01-00-00/610	building board	2600 x 600 x 10 mm	50 boards = 78 m <sup>2</sup>
01-00-00/620	building board	2600 x 600 x 20 mm	50 boards = 78 m <sup>2</sup>
01-00-00/630	building board	2600 x 600 x 30 mm	36 boards = 56.16 m <sup>2</sup>
01-00-00/640	building board	2600 x 600 x 40 mm	36 boards = 56.16 m <sup>2</sup>
01-00-00/650	building board	2600 x 600 x 50 mm	24 boards = 37.44 m <sup>2</sup>

## wedi building boards XL and XXL



Order no.	Description	Dimensions length x width x thickness	Packing unit/ pallet
01-00-00/912	building board	2500 x 900 x 12.5 mm	25 boards = 56.25 m <sup>2</sup>
01-00-00/920	building board	2500 x 900 x 20 mm	25 boards = 56.25 m <sup>2</sup>
01-00-00/930	building board	2500 x 900 x 30 mm	18 boards = 40.50 m <sup>2</sup>
01-00-00/950	building board	2500 x 900 x 50 mm	12 boards = 27 m <sup>2</sup>
01-00-01/612	building board	<b>new</b> 2600 x 1200 x 12.5 mm	25 boards = 78 m <sup>2</sup>
01-00-01/230	building board	2500 x 1200 x 30 mm	18 boards = 54 m <sup>2</sup>
01-00-01/250	building board	2500 x 1200 x 50 mm	12 boards = 36 m <sup>2</sup>

## wedi BA Vapor (Building panel with pre-installed vapour barrier)

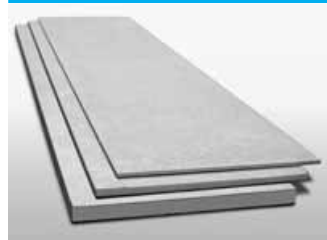

Order no.	Description	Dimensions length x width x thickness	Packing unit/ pallet
01-07-13/112	building board Vapor	<b>new</b> 2500 x 600 x 12.5 mm	50 boards = 75 m <sup>2</sup>
01-07-13/020	building board Vapor	<b>new</b> 2500 x 600 x 20 mm	50 boards = 75 m <sup>2</sup>
01-07-13/050	building board Vapor	<b>new</b> 2500 x 600 x 50 mm	24 boards = 36 m <sup>2</sup>

### Note:

Thickness of BA Vapor boards always plus 1.5 mm thickness for coating.

# wedi BA Construct

## wedi BA Construct lengthwise

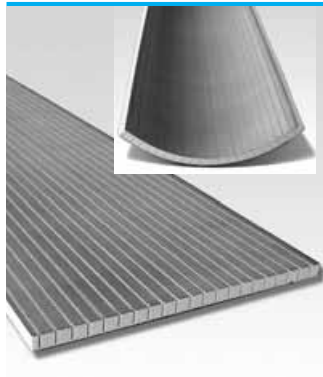

Order no.	Description		Dimensions length x width x thickness	Packing unit/ pallet
01-07-09/010	BA Construct*	<b>new</b>	2500 x 600 x 10 mm	50 boards = 75 m <sup>2</sup>
01-07-09/012	BA Construct*	<b>new</b>	2500 x 600 x 12.5 mm	50 boards = 75 m <sup>2</sup>
01-07-09/020	BA Construct*	<b>new</b>	2500 x 600 x 20 mm	50 boards = 75 m <sup>2</sup>
01-07-09/030	BA Construct		2500 x 600 x 30 mm	36 boards = 54 m <sup>2</sup>
01-07-09/130	BA Construct extra round*	<b>new</b>	2500 x 600 x 30 mm	36 boards = 54 m <sup>2</sup>
01-07-09/040	BA Construct*	<b>new</b>	2500 x 600 x 40 mm	36 boards = 54 m <sup>2</sup>
01-07-09/140	BA Construct extra round*	<b>new</b>	2500 x 600 x 40 mm	36 boards = 54 m <sup>2</sup>
01-07-09/050	BA Construct*	<b>new</b>	2500 x 600 x 50 mm	24 boards = 36 m <sup>2</sup>
01-07-09/150	BA Construct extra round*	<b>new</b>	2500 x 600 x 50 mm	24 boards = 36 m <sup>2</sup>

### BA Construct diameter calculation

	BA 10		BA 12.5		BA 20		BA 30		BA 40		BA 50	
	round	extra round	round	extra round	round	extra round	round	extra round	round	extra round	round	extra round
outer diameter	189	95	232	116	363	182	538	271	714	359	890	448

### Number of full circles per panel (Size: 2500 x 600 mm)

lengthwise	1.0	2.0	0.8	1.6	0.5	1.0	0.4	0.7	0.3	0.5	0.2	0.4
------------	-----	-----	-----	-----	-----	-----	-----	-----	-----	-----	-----	-----

## wedi BA Construct crosswise

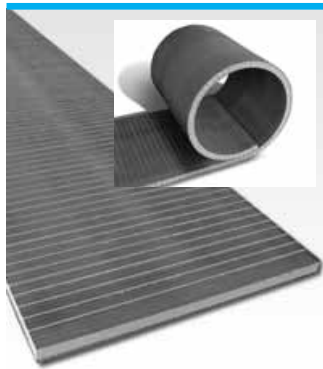

Order no.	Description		Dimensions length x width x thickness	Packing unit/ pallet
01-07-08/010	BA Construct*	<b>new</b>	2500 x 600 x 10 mm	50 boards = 75 m <sup>2</sup>
01-07-08/012	BA Construct*	<b>new</b>	2500 x 600 x 12.5 mm	50 boards = 75 m <sup>2</sup>
01-07-08/020	BA Construct*	<b>new</b>	2500 x 600 x 20 mm	50 boards = 75 m <sup>2</sup>
01-07-08/030	BA Construct		2500 x 600 x 30 mm	36 boards = 54 m <sup>2</sup>
01-07-08/130	BA Construct extra round*	<b>new</b>	2500 x 600 x 30 mm	36 boards = 54 m <sup>2</sup>
01-07-08/040	BA Construct*	<b>new</b>	2500 x 600 x 40 mm	36 boards = 54 m <sup>2</sup>
01-07-08/140	BA Construct extra round*	<b>new</b>	2500 x 600 x 40 mm	36 boards = 54 m <sup>2</sup>
01-07-08/050	BA Construct*	<b>new</b>	2500 x 600 x 50 mm	24 boards = 36 m <sup>2</sup>
01-07-08/150	BA Construct extra round*	<b>new</b>	2500 x 600 x 50 mm	24 boards = 36 m <sup>2</sup>

### BA Construct diameter calculation

	BA 10		BA 12.5		BA 20		BA 30		BA 40		BA 50	
	round	extra round	round	extra round	round	extra round	round	extra round	round	extra round	round	extra round
outer diameter	189	95	232	116	363	182	538	271	714	359	890	448

### Number of full circles per panel (Size: 2500 x 600 mm)

crosswise	4.2	8.4	3.4	6.8	2.2	4.4	1.5	2.9	1.1	2.2	0.9	1.8
-----------	-----	-----	-----	-----	-----	-----	-----	-----	-----	-----	-----	-----

### Note:

Delivery time for BA Construct which is marked with \*: approx. 3 weeks after receipt of the order.

# wedi building board accessories

## wedi waterproof sealing and joint reinforcement tapes



Order no.	Description	Dimensions length x width (roll)	Packing unit/ box
09-52-20/053	joint reinforcement tape	25 m x 125 mm	1 roll
09-52-25/053	joint reinforcement tape, self-adhesive	25 m x 125 mm	1 roll
09-52-10/052	joint reinforcement tape	50 m x 600 mm	1 roll
09-52-15/052	joint reinforcement tape, self-adhesive	50 m x 600 mm	1 roll



Order no.	Description	Dimensions length x width (roll)	Packing unit/ box
09-51-10/352	sealing tape fleece laminated <b>new</b>	50 m x 120 mm	1 roll
09-51-10/311	sealing tape fleece laminated <b>new</b>	10 m x 120 mm	1 roll
09-51-00/352	sealing tape fleece laminated <b>new</b>	50 m x 100 mm	1 roll

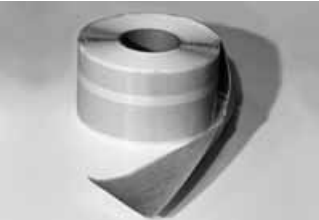

Order no.	Description	Dimensions length x width	Packing unit/ box
09-51-00/252	wedi S-sealing tape, self-adhesive <b>new</b>	50 m x 100 mm	2 rolls à 25m



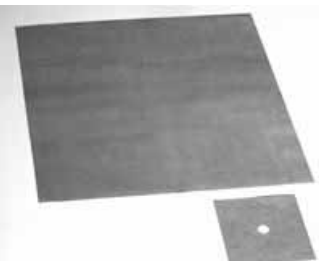

Order no.	Description	Dimensions flanges	Packing unit/ box
09-51-30/001	waterproof sealing tape, inside corner (fleece laminated) <b>new</b>	120 x 120 mm	25 units
09-51-35/001	waterproof sealing tape, outside corner (fleece laminated) <b>new</b>	115 x 115 mm	25 units





Order no.	Description	Dimensions length x width	Packing unit/ box
09-51-20/010	sealing collar (fleece laminated) <b>new</b>	100 x 100 mm	25 units
09-51-20/040	sealing collar (fleece laminated) <b>new</b>	400 x 400 mm	10 units

## Fixing aids

	Order no.	Description	Packing unit/ box
	09-53-00/191	wedisteck WE	100 pieces

	Order no.	Description	Packing unit/ box
	09-53-00/192	wedisteck RK	100 pieces

	Order no.	Description	Packing unit/ box
	09-53-00/193	wedisteck BA	100 pieces

	Order no.	Description	Dimensions length	Packing unit/ box
	09-50-00/020	Fixing anchor	20 mm	100 pieces

	Order no.	Description	Dimensions length	Packing unit/ box
	09-49-20/104	metal dowel, galvanized	50 mm	100 pieces
	09-49-20/108	metal dowel, galvanized	80 mm	100 pieces
	09-49-20/111	metal dowel, galvanized	110 mm	100 pieces
	09-49-20/114	metal dowel, galvanized	140 mm	100 pieces
	09-49-20/122	metal dowel, galvanized	200 mm	100 pieces
	09-49-40/108	stainless steel dowel V <sub>2</sub> A	80 mm	100 pieces
	09-49-40/111	stainless steel dowel V <sub>2</sub> A	110 mm	100 pieces
	09-49-40/114	stainless steel dowel V <sub>2</sub> A	140 mm	100 pieces

	Order no.	Description	Packing unit/ box
	09-48-60/106	washer, galvanised	100 pieces
	09-48-60/238	washer, stainless steel	100 pieces

## wedi adhesive and sealing material

	Order no.	Description	Packing unit/ box
	07-69-02/000	adhesive and sealing material	20 pieces



## wedi BA Balco

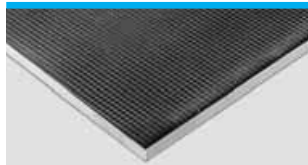

Order no.	Description	Dimensions length x width	Packing unit/ pallet
01-13-00/010	BA Balco 10 mm thick	1200 x 800 mm	75 boards = 72 m <sup>2</sup>
01-13-00/020	BA Balco 20 mm thick	1200 x 800 mm	50 boards = 48 m <sup>2</sup>
01-13-00/050	BA Balco 50 mm thick	1200 x 800 mm	24 boards = 23.04 m <sup>2</sup>

**Note:** For applications with wedi BA Balco panels you must use the wedi S-sealing tape.

## wedi BA Balco sloping board

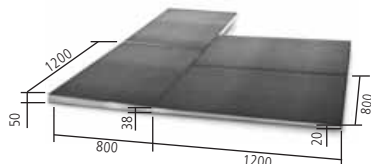

Order no.	Description	Dimensions length x width	Packing unit/ box
01-13-00/058	BA Balco GP 20/38 mm, longitudinal	1200 x 800 mm	24 boards = 23.04 m <sup>2</sup>
01-13-00/059	BA Balco GP 38/50 mm, crosswise	1200 x 800 mm	24 boards = 23.04 m <sup>2</sup>

**Note:** For applications with wedi BA Balco panels you must use the wedi S-sealing tape.

## wedi BA Balco stepboard

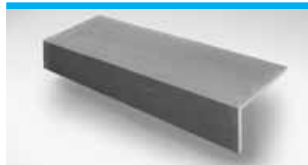

Order no.	Description	side length x length x thick	Packing unit/ pallet
07-43-11/394	BA Balco stepboard	200/400 x 1200 x 20 mm	20 units

**Note:** For applications with wedi BA Balco panels you must use the wedi S-sealing tape.

## wedi BA Balco drain



Order no.	Description	Dimensions length x width	Packing unit/ box
01-13-10/055	BA Balco drain DN 50 mm	400 x 400 mm	1 piece
01-13-10/056	BA Balco drain DN 70 mm	400 x 400 mm	1 piece

**Note:** For applications with wedi BA Balco panels you must use the wedi S-sealing tape.

## wedi S-sealing Tape

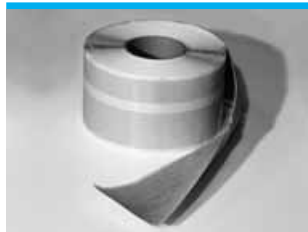

Order no. length x width	Description box	Dimensions	Packing unit/
09-51-00/252	wedi S-sealing tape, self-adhesive	50 m x 100 mm	2 rolls à 25m

**Note:** For applications with wedi BA Balco panels you must use the wedi S-sealing tape.

## wedi Balco Combit special primer



Order no.	Description	Packing unit
09-54-02/000	Balco Combit special primer for bituminous roofing felts	1 tin à 1 kg

Contents: 1 kg combined component (1 kg liquid component, 10 g + 15 g cement powder)

Coverage rate: approx. 1 kg for 6 m<sup>2</sup> of bituminous sheeting

## wedi Balco MBM middle bed mortar



Order no.	Description	Packing unit
09-54-03/000	Balco MBM middle bed mortar, quick-drying	25 kg sack

Content: 25 kg sack made of kraft paper with polyethylene inset

### Attention:

Coverage rate when using middle bed mortar: Approx. 17 kg/m<sup>2</sup> with an average application of 15 mm.

Application thickness between 5-20 mm possible

# wedi building board systems

## wedi pipe covering box

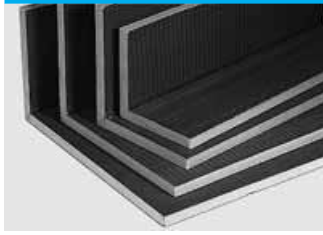

Order no.	Description	Dimensions length x thickness	Packing unit/ pallet
07-43-00/091	pipe covering box <b>150 x 150 mm</b>	2500 x 20 mm	60 units
07-43-00/092	pipe covering box <b>200 x 200 mm</b>	2500 x 20 mm	40 units
07-43-00/093	pipe covering box <b>300 x 300 mm</b>	2500 x 20 mm	40 units
07-43-00/094	pipe covering box <b>200 x 400 mm</b>	2500 x 20 mm	40 units
07-43-00/691	pipe covering box <b>150 x 150 mm</b>	2600 x 20 mm	60 units
07-43-00/692	pipe covering box <b>200 x 200 mm</b>	2600 x 20 mm	40 units
07-43-00/693	pipe covering box <b>300 x 300 mm</b>	2600 x 20 mm	40 units
07-43-00/694	pipe covering box <b>200 x 400 mm</b>	2600 x 20 mm	40 units

## wedi U-shaped angle unit

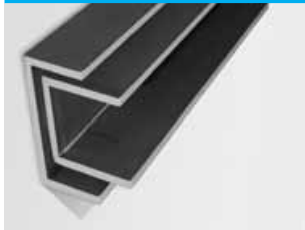

Order no.	Description	Dimensions length x thickness	Packing unit/ pallet
07-43-00/695	U-shaped angle unit 200 x 200 x 200 mm <b>new</b>	2600 x 20 mm	40 units
07-43-00/696	U-shaped angle unit 150 x 300 x 150 mm <b>new</b>	2600 x 20 mm	30 units

## wedi bath/shower panels

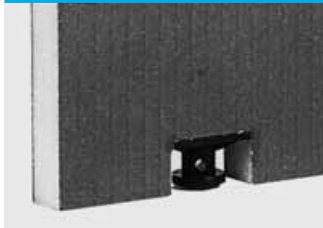

Order no.	Description	Dimensions length x width x thickness	Packing unit/ pallet
07-38-20/180	side panel/bath	1800 x 600 mm x 30 mm	30 units
07-38-20/076	end panel/bath	760 x 600 mm x 30 mm	30 units
07-38-20/241	side panel/bath	2100 x 600 mm x 30 mm	30 units
07-38-30/019	side panel/shower	900 x 200 mm x 30 mm	30 units
07-38-30/028	side panel/shower	900 x 300 mm x 30 mm	30 units

## wedi Bathbox



Order no.	Description	Dimensions length x width x height	Packing unit/ pallet
07-38-21/020	wedi Bathbox Flex <b>new</b>	max. 1770 x 770 x 600 mm	10 units
07-38-21/010	wedi Bathbox Classic <b>new</b>	1670 x 720 x 600 mm	10 units

### Note:

- Bathbox Classic: suitable for standard bath tubs (1700 x 750 x 600 mm)
- Bathbox Flex: suitable for bath tubs from 1500 to 1800 mm length and 650 to 800 mm width.

## wedibloc

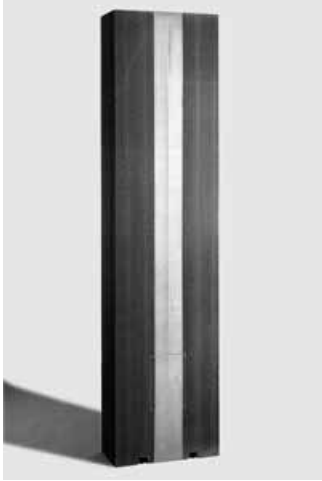

Order no.	Description	Dimensions length x width x depth	Packing unit/ pallet
04-15-00/000	wedibloc	2600 x 600 x 300 mm	6 pieces

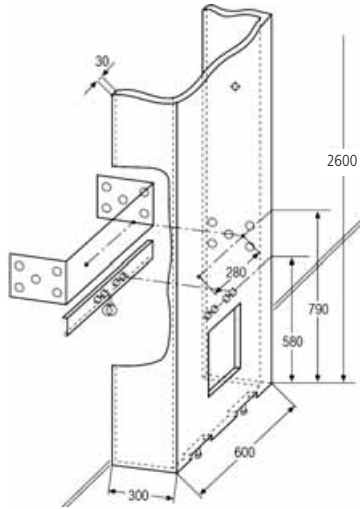

## wedibloc accessories



Order no.	Description	Dimensions length x width	Packing unit
04-15-10/038	inspection door white	300 x 300 mm	1 piece
04-15-10/039	inspection door white	400 x 400 mm	1 piece
04-15-10/037	inspection door white	500 x 500 mm	1 piece

# wedi Fundo

## wedi Fundo scope of delivery:

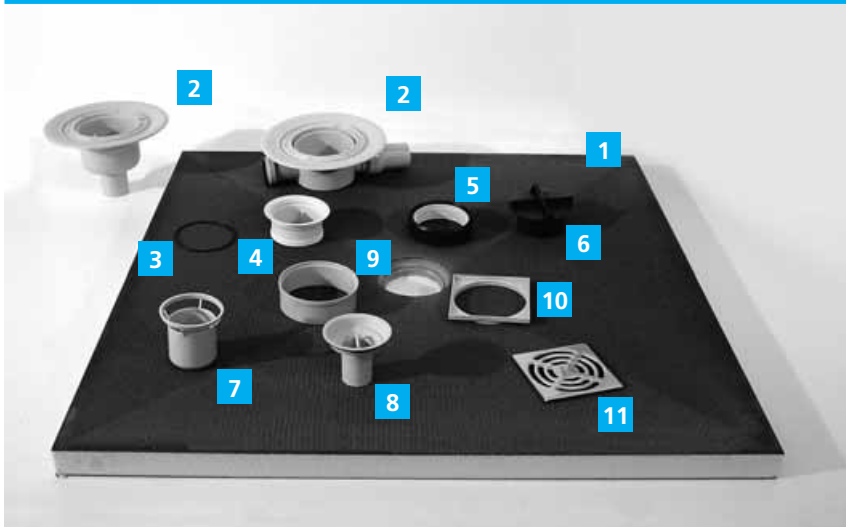

- 1 wedi Fundo floor element
- 2 drain body, horizontal or vertical
- 3 O-Ring
- 4 screw-type valve
- 5 main sealing collar
- 6 cap tool
- 7 trap cup
- 8 siphon
- 9 extension collar
- 10 plastic frame
- 11 stainless steel grate

## wedi Fundo vertical drain



Order no.	Description	Absorbtion capacity	Packing unit
07-37-89/000	Fundo DN 50, vertical	1.00 litre/second	1 piece
07-37-89/070	Fundo DN 70, vertical <b>new</b>	0.88 litre/second	1 piece

## wedi Fundo horizontal drain



Order no.	Description	Absorbtion capacity	Packing unit
07-37-90/000	Fundo DN 50, horizontal	0.80 litre/second	1 piece

### Note:

Please specify when ordering the type of drain required: horizontal DN 50, vertical DN 50 or vertical DN 70!

Technical advice for wedi Fundo on page 20.

### wedi Fundo square / central drain

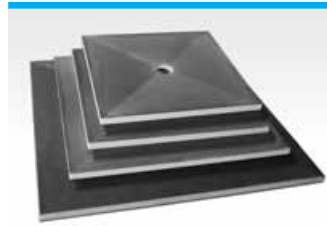

Order no.	Description	Dimensions length x width x thickness	Packing unit/ pallet
07-37-15/170	Fundo square	900 x 900 x 40 mm	10 units
07-37-15/131	Fundo square	1000 x 1000 x 40 mm	10 units
07-37-15/171	Fundo square	1200 x 1200 x 40 mm	10 units
07-37-15/175	Fundo square	1500 x 1500 x 40 mm	10 units

### wedi Fundo square / offset drain

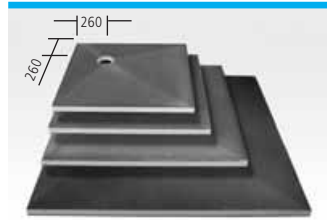

Order no.	Description	Dimensions length x width x thickness	Packing unit/
07-37-62/170	Fundo square	900 x 900 x 40 mm	1 piece
07-37-15/531	Fundo square <b>new</b>	1000 x 1000 x 40 mm	1 piece
07-37-62/171	Fundo square	1200 x 1200 x 40 mm	1 piece
07-37-15/575	Fundo square <b>new</b>	1500 x 1500 x 40 mm	1 piece

### wedi Fundo rectangle / central drain



Order no.	Description	Dimensions length x width x thickness	Packing unit/ box
07-37-16/174	Fundo rectangle	1200 x 900 x 40 mm	1 piece

### wedi Fundo rectangle in bath tub measurements



Order no.	Description	Dimensions length x width x thickness	Packing unit/ box
07-37-15/580	Fundo in bath tub measurements <b>new</b>	1800 x 900 x 40 mm	1 piece
07-37-15/180	Fundo in bath tub measurements, offset drain <b>new</b>	1800 x 900 x 40 mm	1 piece

### wedi Fundo kit quarter circle, offset drain

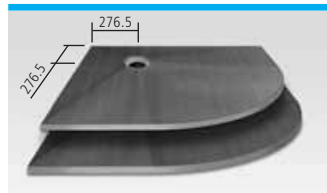

Order no.	Description	Dimensions length x width x thickness/radius	Packing unit/ box
07-37-15/576	Fundo quarter circle, offset drain <b>new</b>	900 x 900 x 40/550 mm	1 piece
07-37-58/000	Fundo quarter circle, offset drain	1000 x 1000 x 40/550 mm	1 piece

## **wedi Fundo - custom made shower bases**

---

- The position of the drain can be placed with negligible tolerance in millimetres.
- The scope of delivery for a wedi Fundo floor element always includes a drain unit with stainless steel grate and plastic frame in the dimensions 120 x 120 mm.
- Production time for custom made shower bases approx. 4 weeks.

### **Note:**

---

Technical data for wedi Fundo shower elements on page 20.

# wedi Fundo

## wedi Fundo kit spiral



Illustration: Right entry  
Thickness of floor element: 50 mm

Order no.	Description	Packing unit/ pallet
07-37-50/000*	Fundo spiral incl. shower partition 2050 mm high	1 piece
07-37-50/250**	Fundo spiral incl. shower partition 2550 mm high	1 piece
07-37-54/065	Fundo spiral floor element only/left entry	1 piece
07-37-54/066	Fundo spiral floor element only/right entry	1 piece
04-17-08/000	Fundo spiral partition only 2015 mm high	1 piece
04-17-08/050	Fundo spiral wall extension element only 500 mm	1 piece

- \*Accessories included:  
 1 floor element  
 8 shower partition elements  
 7 strips of building board  
 2 x 25 m joint reinforcement tape, self-adhesive  
 4 pcs. of wedi adhesive and sealing material  
 \*\* 1 wall extension element

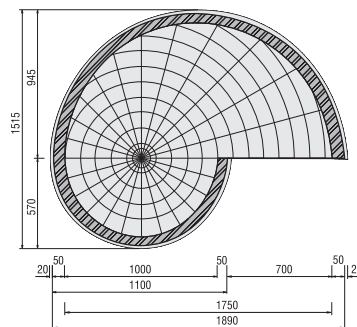

## wedi Fundo kit round



Inner diameter 1000 mm  
 Outer diameter 1140 mm  
 Thickness of floor element 40 mm

Order no.	Description	Packing unit/ pallet
07-37-63/000*	Fundo round incl. shower partition 2040 mm high	1 piece
07-37-63/250**	Fundo round incl. shower partition 2540 mm high	1 piece
07-37-17/000	Fundo round floor element only	1 piece
04-17-09/000	Fundo round partition only 2015 mm high	1 piece
04-17-09/050	Fundo spiral wall extension element only 500 mm	1 piece

- \*Accessories included:  
 1 floor element  
 5 shower partition elements  
 4 strips of building board  
 2 x 25 m joint reinforcement tape, self-adhesive  
 3 pcs. of wedi adhesive and sealing material  
 \*\* 1 wall extension element

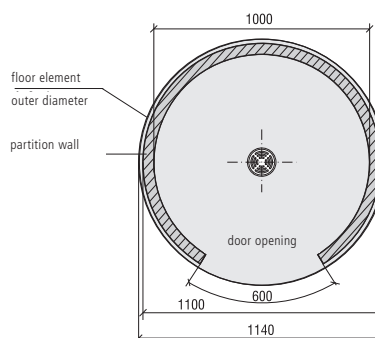

## wedi Fundo kit pentagon

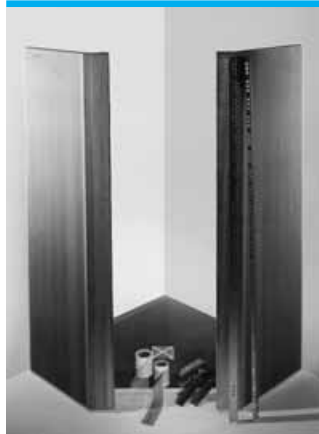

Thickness of floor element: 40 mm

Order no.	Description	Packing unit/ pallet
07-37-56/000*	Fundo pentagon incl. shower partition 2150 mm high	1 piece
07-37-57/000	Fundo pentagon floor element only	1 piece
04-17-10/000	Fundo pentagon partition only 2150 mm high	1 piece

- \*Accessories included:  
 1 floor element  
 2 shower partition elements  
 Installation material (dowels, screws, washers)  
 10 m wedi joint reinforcement tape, self-adhesive  
 10 m wedi sealing tape  
 4 U-profiles (short)  
 2 U-profiles (long)

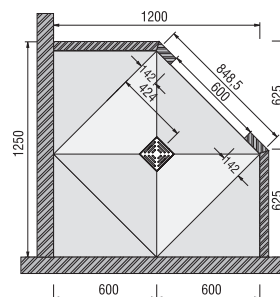

### Note:

Technical advice for wedi Fundo on page 20.

## wedi Fundo VBK spiral



Illustration: Right entry  
Thickness of floor element: 50 mm

Order no.	Description	Packing unit/ pallet
07-37-50/100*	wedi Fundo VBK spiral, height 2050 mm consisting of floor element and partition wall	1 piece
04-17-08/051	wedi Fundo extension element Fundo VBK spiral, height 500 mm	1 piece

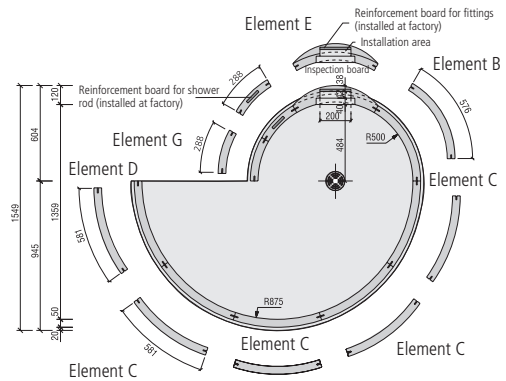
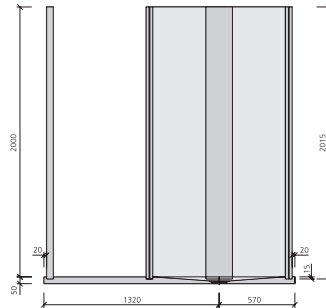

\*Scope of delivery: Fundo VBK round:

- 1 floor element (optional: with left or right entry)
- 1 partition wall, element G
- 1 partition wall, element E  
(with reinforcement for fittings and head shower)
- 1 inspection board (BA 40)

- 1 partition wall, element B
- 4 partition walls, element C
- 8 strips of building board
- 2 x 25 m joint reinforcement tape, self-adhesive
- 5 pcs. of wedi adhesive and sealing material

## wedi Fundo VBK round



Thickness of floor element: 40mm

Order no.	Description	Packing unit/ pallet
07-37-63/100 *	wedi Fundo VBK round, height 2040 mm consisting of floor element and partition wall	1 piece
04-17-09/051	wedi Fundo extension element Fundo VBK round, height 500 mm	1 piece

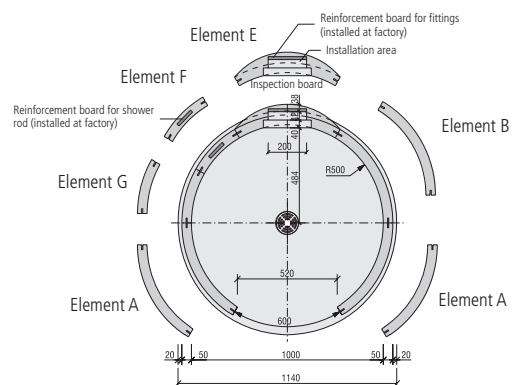
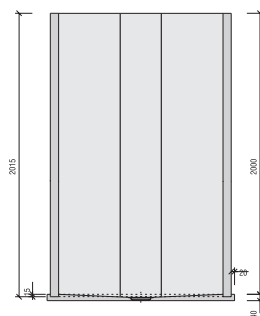

Scope of delivery: Fundo VBK round:

- 1 floor element
- 1 partition wall, element G
- 1 partition wall, element F  
(with reinforcement for shower rod)
- 1 partition wall, element E  
(with reinforcement for fittings and head shower)

- 1 inspection board (BA 40)
- 1 partition wall, element B
- 2 partition wall end pieces, element A
- 5 strips of building board
- 2 x 25 m joint reinforcement tape, self-adhesive
- 4 pcs. of wedi adhesive and sealing material



# wedi Fundo

## wedi Fundo Phanos

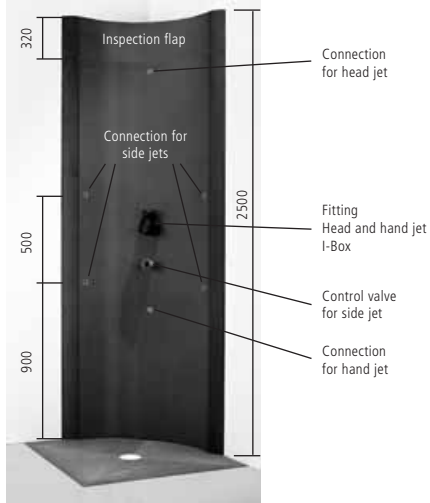

Order no.	Description	Dimensions length x width	Packing unit/pallet
07-44-10/000	Fundo Phanos	see diagram	1 piece

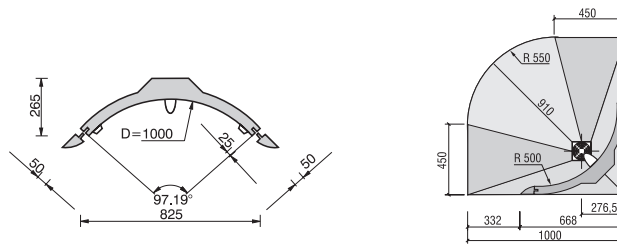

## \*wedi Fundo kits Tulipano, Labirinto, Rosa

### wedi Fundo Tulipano



Order no.	Description	Dimensions length x width	Packing unit/pallet
07-37-44/000	Fundo Tulipano	see diagram	1 piece
07-37-40/000	Fundo Labirinto <b>square design</b>	see diagram	1 piece
07-37-41/000	Fundo Labirinto <b>rectangle design</b>	see diagram	1 piece
07-37-42/000	Fundo Rosa <b>corner application</b>	see diagram	1 piece
07-37-43/000	Fundo Rosa <b>free-standing application</b>	see diagram	1 piece

### \*wedi Fundo Labirinto, design: square or rectangle

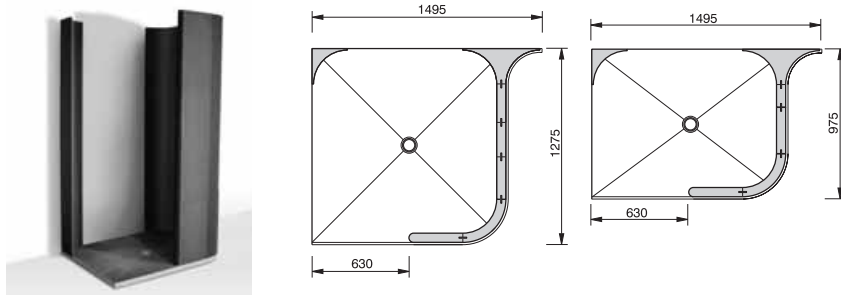

### \*wedi Fundo Rosa, design: corner application or free-standing application

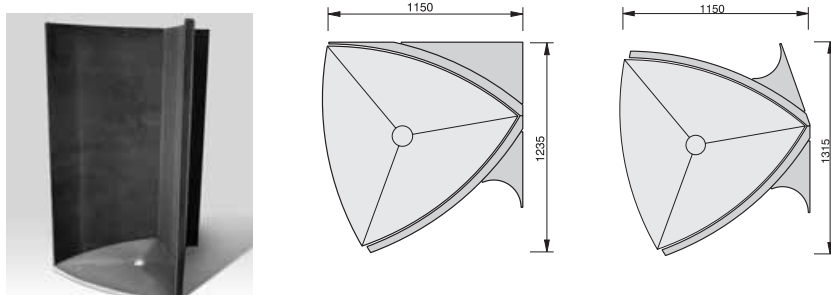

#### \*Note:

Production time: approx. 4 weeks after receipt of the order.

# wedi Fundo

## Genuine glass door for Fundo round



Order no.	Description	Dimensions length x width x thickness/radius	Packing unit
60-80-01/100	genuine glass door for Fundo round including aluminium profiles, lustrous	1990 x 558 x 6 mm/530 mm	1 piece

## Sliding glass door for round shower



Order no.	Description	Dimensions length x width x thick/radius	Packing unit
60-80-01/200	sliding glass door for Fundo round	1900 x 650 x 6 mm/530 mm	1 piece

## wedi Fundo Easy Set subconstruction system

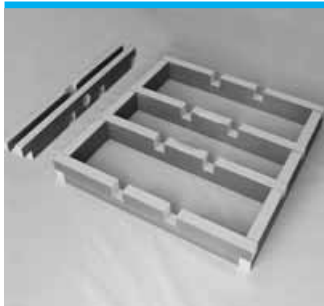

Order no.	Description	Dimensions length x width x height	Packing unit
07-37-23/000	Fundo Easy Set	900 x 900 x 100 mm	1 piece
07-37-24/000	Fundo Easy Set	1200 x 1200 x 100 mm	1 piece
07-37-24/174	Fundo Easy Set	<b>new</b> 900 x 1200 x 100 mm	1 piece
07-37-24/131	Fundo Easy Set	<b>new</b> 1000 x 1000 x 100 mm	1 piece
07-37-24/175	Fundo Easy Set	<b>new</b> 1500 x 1500 x 100 mm	1 piece

Only suitable for Fundo floor elements with central drain!

## wedi Fundo sealing set



Order no.	Description	Packing unit
07-37-96/000	wedi Fundo sealing set	1 bucket *

\* Content: 2.5 kg Powder component, 0.8 l liquid component, 10 m waterproof sealing tape, 2 internal corners.  
The wedi Fundo sealing set is sufficient for installing a Fundo plus a Fundo shower partition.

### Note:

Technical advice for wedi Fundo on page 20.

# wedi Fundo

## wedi drain screw-in



Order no.	Description	Dimensions length x width x height	Packing unit
07-37-70/000	stainless steel grate, screw-in (including stainless steel frame)	120 x 120 x 10 mm	1 piece

## wedi stainless steel grate



Order no.	Description	Dimensions length x width x height	Packing unit
07-37-66/000	stainless steel grate including plastic frame <b>new</b>	100 x 100 x 8 mm	1 piece
07-37-66/150	stainless steel grate including plastic frame <b>new</b>	150 x 150 x 8 mm	1 piece

## wedi frame and drain round



Order no.	Description	Dimensions diameter x height	Packing unit
07-37-71/000	stainless steel grate, round	ø 120 x 5 mm	1 piece
07-37-93/000	stainless steel frame, round	ø 120 x 9 mm	1 piece
07-37-93/001	stainless steel grate, super flat <b>new</b>	ø 120 x 2 mm	1 piece

## wedi frame, stainless steel



Order no.	Description	Dimensions length x width x height	Packing unit
07-37-94/000	stainless steel frame	120 x 120 x 10 mm	1 piece
07-37-94/001	stainless steel frame, super flat <b>new</b> The stainless steel grate is part of the Fundo floor element.	120 x 120 x 6.2 mm	1 piece

## wedi frame and grate "deluxe"



Order no.	Description	Dimensions length x width x height	Packing unit
07-37-97/000	stainless steel frame and grate "deluxe"	120 x 120 x 10 mm	1 piece

## wedi Fundo fire protection collar



Order no.	Description	Packing unit
07-37-49/000	Fundo fire protection collar for drain DN 50, vertical <b>new</b>	1 piece

## Technical advice wedi Fundo

---

- Please specify the necessary drain type at the time of ordering:  
horizontal DN 50, vertical DN 50 or vertical DN 70.
- Absorbtion capacity of drain:  
DN 70 vertical: 0.88 litre/sec.  
DN 50 vertical: 1.00 litre/sec.  
DN 50 horizontal: 0.80 litre/sec.
- The shower partitions round and pentagon are reinforced at the door opening along both enbrasure lengths enabling the fastening of the door.
- The shower partitions round and pentagon also have a wall thickness of 50 mm and are provided with steel tracks (exception: wedi Fundo spiral) to enable the fastening of the door.
- The wedi Fundo system can also be furnished with the authorized fire protection solution wedi Fundo Fire Protection (order no. 07-37-49/000).
- wedi Fundo floor elements can of course be shortened on site, although the geometry of the element must be taken into consideration (slope).
- wedi Fundo Tulipano, Labirinto, Rosa and Pentagon. Content of the kits: floor element including drain technology, Fundo shower partitions, joint reinforcement tape and waterproof sealing tape; with wedi Fundo Tulipano and wedi Fundo Pentagon additional fastening tracks.

# wedi Sanoasa

## wedi Sanoasa seating Comodo with slope to front

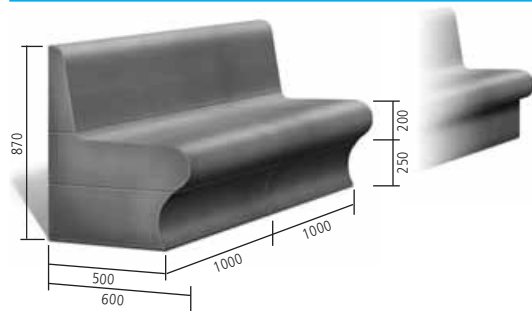

Order no.	Description	Dimensions in mm
07-64-38/000	seating Comodo, 1° slope to front	length 2000 mm
07-64-37/000	seating Comodo, straight finish	length 1000 mm
07-64-37/500	seating Comodo, round finish	length 1000 mm

The seating is delivered in two separate parts.  
Length of top section: 2000 mm  
Length of base: 2 x 1000 mm

## wedi Sanoasa seating Comodo with slope to back

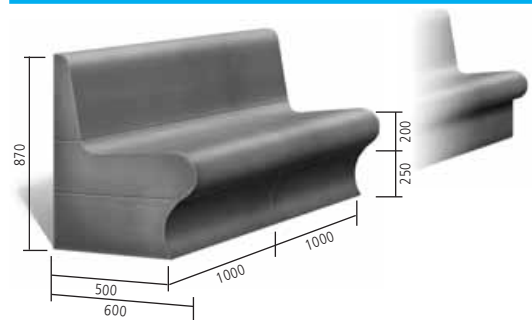

Order no.	Description	Dimensions in mm
07-64-36/000	seating Comodo, 3.5° slope to back length	2000 mm
07-64-37/000	seating Comodo, straight finish length	1000 mm
07-64-37/500	seating Comodo, round finish length	1000 mm

The seating is delivered in two separate parts.  
Length of top section: 2000 mm  
Length of base 2 x 1000 mm

## wedi Sanoasa bench Piccolo with slope to front

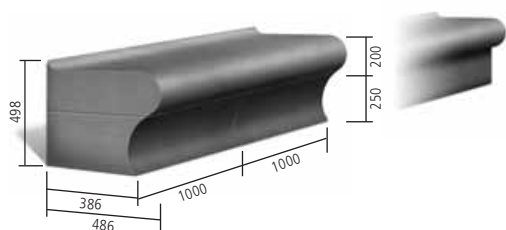

Order no.	Description	Dimensions in mm
07-64-41/000	bench Piccolo, 1° slope to front length	2000 mm
07-64-41/500	bench Piccolo, straight finish length	1000 mm
07-64-41/600	bench Piccolo, round finish length	1000 mm

## wedi Sanoasa lounger Forma

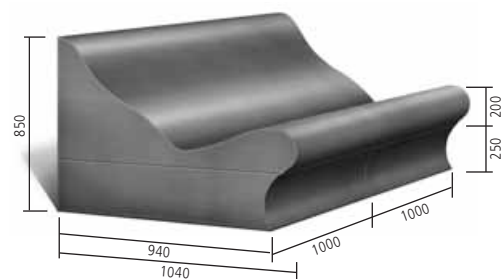

Order no.	Description	Dimensions in mm
07-64-42/000	lounger Forma	length 2000 mm
07-64-43/000	base unit lounger Forma, straight finish	length 1000 mm
07-64-43/500	base unit lounger Forma, round finish	length 1000 mm

## wedi Sanoasa seating Collina

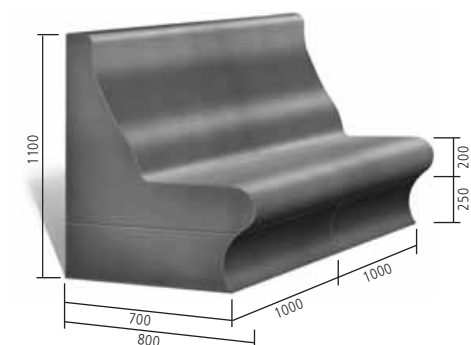

Order no.	Description	Dimensions in mm
07-64-44/000	seating Collina, 1° slope to front length	2000 mm
07-64-45/000	base unit seating Collina, straight finish length	1000 mm
07-64-45/500	base unit seating Collina, round finish length	1000 mm

### Note:

Technical advice about wedi Sanoasa loungers and seats on page 30.

Production time with pre-installed heating set: approx. 4-5 weeks after receipt of the order.

# wedi Sanoasa

## wedi Sanoasa lounger Corpo

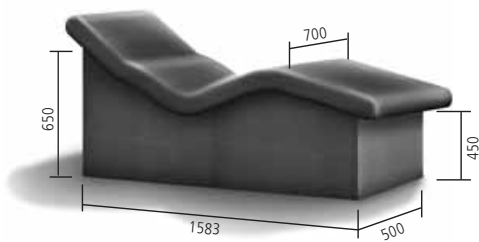

Order no.	Description	Dimensions in mm
07-64-30/000	top section Corpo	see diagram
07-64-31/000	base unit Corpo	see diagram

## wedi Sanoasa lounger Disegno

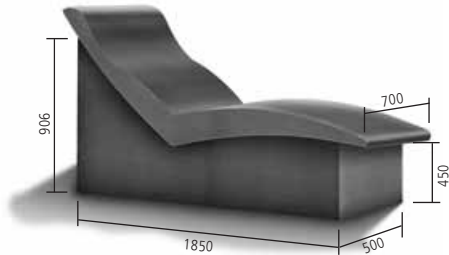

Order no.	Description	Dimensions in mm
07-64-32/000	top section Disegno	see diagram
07-64-33/000	base unit Disegno	see diagram

## wedi Sanoasa lounger Onda



Order no.	Description	Dimensions in mm
07-64-39/000	top section Onda	see diagram
07-64-40/000	base unit Onda	see diagram

## wedi Sanoasa rocking lounger "Cillato"

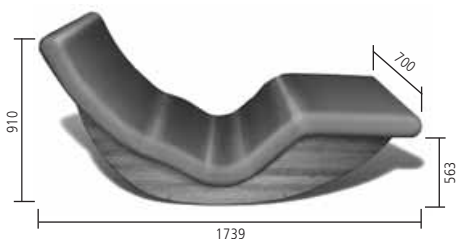

Order no.	Description	Dimensions in mm
07-64-46/000	Cillato rocking lounger including electrical heating set <b>new</b>	see diagram

Width of top section: 700 mm  
Width of wooden base: 500 mm

### Note:

Production time with pre-installed heating set: approx. 4 weeks after receipt of the order.

The delivery time for the rocking lounger "Cillato" is approx. 5 working days due to the pre-installed heating set.

## wedi Sanoasa accessories

Order no.	Description	Packing unit
07-65-00/000	electrical heating set for seating Comodo	1 set
07-65-01/000	electrical heating set for loungers (Corpo, Disegno, Onda)	1 set
07-65-02/000	water heating set for seating Comodo	1 set
07-65-03/000	water heating set for loungers (Corpo, Disegno, Onda)	1 set

## wedi Sanoasa Home no. 1, tileable steam shower



Order no.	Description	Dimensions	Packing unit
07-66-11/000	Sanoasa no. I with pitched roof	see drawing	1 unit
07-66-10/000	Sanoasa no. I with flat roof	see drawing	1 unit
67-67-00/000	optional: stainless steel door frame with glass door		1 unit
67-67-40/000	optional: panel heating		1 unit
67-67-40/100	optional: seat bench heating		1 unit
67-66-11/000	optional: epoxy resin coating pitched roof		1 unit
67-66-10/000	optional: epoxy resin coating flat roof		1 unit

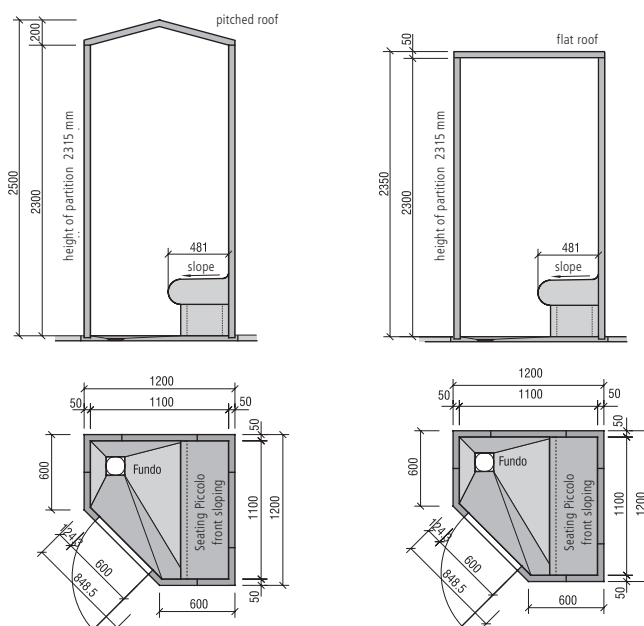

## wedi Sanoasa Home no. 2, tileable steam shower



Order no.	Description	Dimensions	Packing unit
07-66-21/000	Sanoasa no. II with tunnel roof see drawing	see drawing	1 unit
07-66-20/000	Sanoasa no. II with flat roof see drawing	see drawing	1 unit
67-67-00/000	optional: stainless steel frame with glass door		1 unit
67-67-41/000	optional: panel heating		1 unit
67-67-41/100	optional: seat bench heating		1 unit
67-66-21/000	optional: epoxy resin coating tunnel roof		1 unit
67-66-20/000	optional: epoxy resin coating flat roof		1 unit

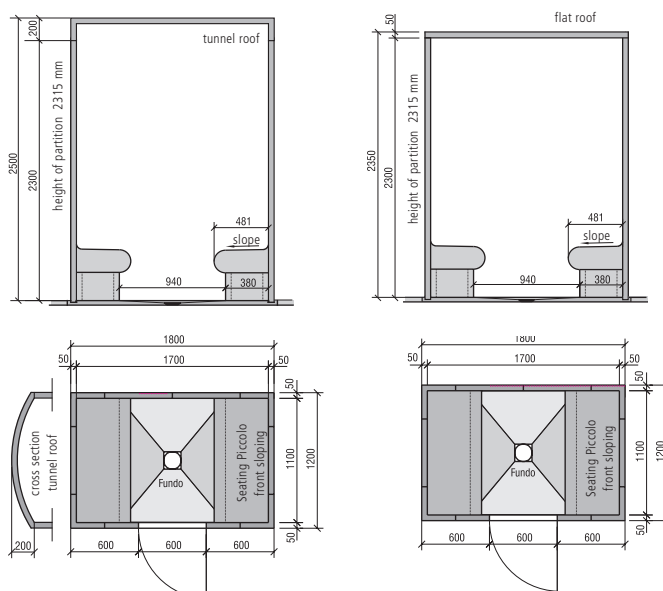

## wedi Sanoasa Home no. 3, tileable steam shower



Order no.	Description	Dimensions	Packing
07-66-31/000	Sanoasa no. III with dome roof	see drawing	1 unit
07-66-30/000	Sanoasa no. III with flat roof	see drawing	1 unit
67-67-00/000	optional: stainless steel door frame with glass door		1 unit
67-67-42/000	optional: panel heating		1 unit
67-67-42/100	optional: seat bench heating		1 unit
67-66-31/000	optional: epoxy resin coating dome roof		1 unit
67-66-30/000	optional: epoxy resin coating flat roof		1 unit

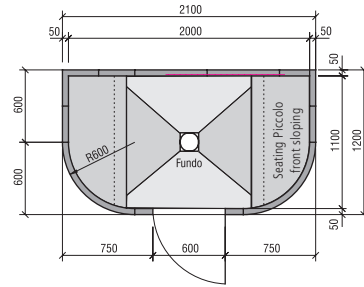
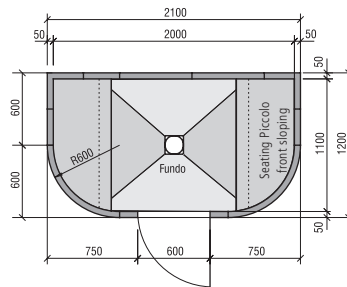
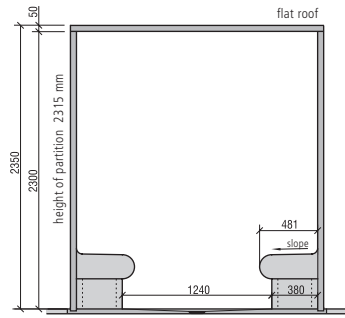
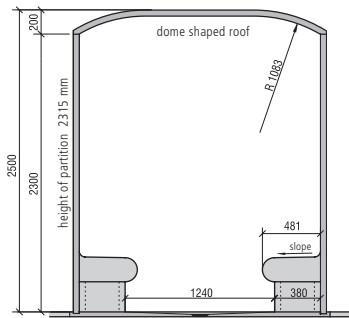

## di Sanoasa Home no. 4, tileable steam shower



Order no.	Description	Dimensions	Packing
07-66-41/000	Sanoasa no. IV with pitched roof	see drawing	1 unit
07-66-40/000	Sanoasa no. IV with flat roof	see drawing	1 unit
67-67-00/000	optional: stainless steel door frame with glass door		1 unit
67-67-43/000	optional: panel heating		1 unit
67-67-43/100	optional: seat bench heating		1 unit
67-66-41/000	optional: epoxy resin coating pitched roof		1 unit
67-66-40/000	optional: epoxy resin coating flat roof		1 unit

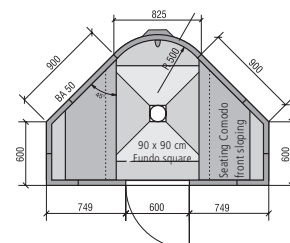
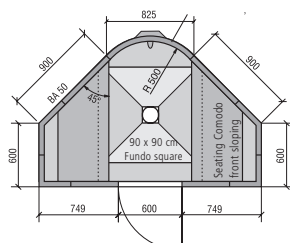
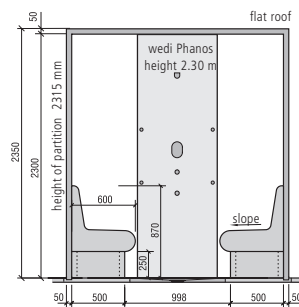
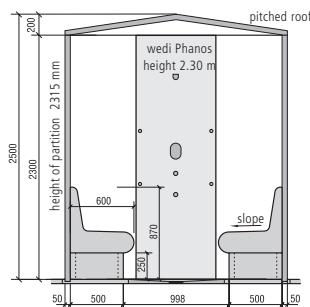



## wedi Sanoasa Home no. 5, tileable steam shower



Order no.	Description	Dimensions	Packing
07-66-50/000	Sanoasa no. V with tunnel roof	see drawing	1 unit
67-67-00/100	optional: door frame including glass door		1 unit
67-67-44/000	optional: panel heating		1 unit
67-67-44/100	optional: seat bench heating		1 unit
67-66-50/000	optional: epoxy resin coating tunnel roof		1 unit

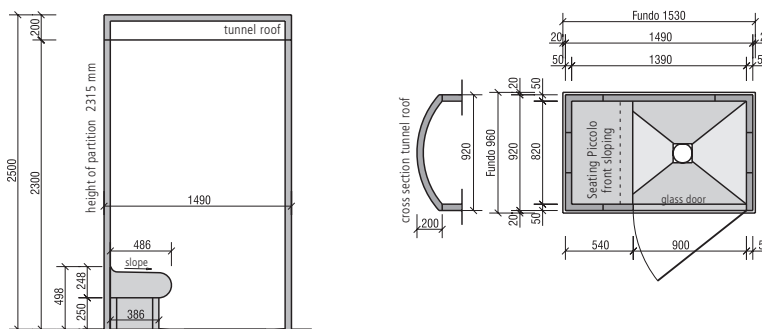

## wedi Sanoasa Home no. 6, tileable steam shower



Order no.	Description	Dimensions	Packing
07-66-60/000	Sanoasa no. VI with tunnel roof	see drawing	1 unit
67-67-00/200	optional: glass door and glass screen		1 unit
67-67-44/000	optional: panel heating		1 unit
67-67-44/100	optional: seat bench heating		1 unit
67-66-50/000	optional: epoxy resin coating tunnel roof		1 unit

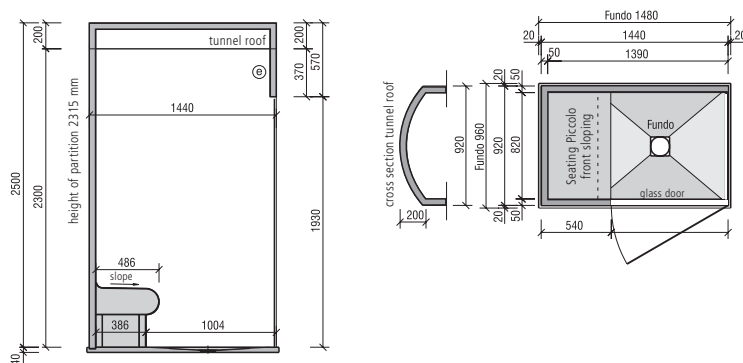

### Note:

Technical advice on page 30.

## wedi door frames

Order no.	Description	dimensions of the rebate width x height	Packing
07-64-00/012	stainless steel door frame with glass door for 80 mm wall thickness	591 x 1983 mm	1 unit
07-64-00/022	stainless steel door frame with glass door for 80 mm wall thickness	716 x 1983 mm	1 unit
67-67-00/000	stainless steel door frame with glass door for 50 mm wall thickness	591 x 1983 mm	1 unit
07-64-00/023	aluminium door frame with glass door for 80 mm wall thickness	591 x 1983 mm	1 unit
07-64-00/024	aluminium door frame with glass door for 80 mm wall thickness	716 x 1983 mm	1 unit

## wedi Sanoasa Home no. 7, tileable steam shower



Order no.	Description	Packing
07-66-70/000*	Sanoasa Home no. 7	1 unit
07-66-70/110	optional: pre-installed vapour barrier <span style="float: right;"><b>new</b></span>	1 unit
07-64-00/106	optional: shower wall panel "deluxe"	1 unit
07-64-00/108	optional: LED technology set of 4 lamps	1 unit
07-64-00/109	optional: fibre glass cable 50 fibres/light points	1 unit
60-05-02/002	optional: cover plate for steam outlet nozzle made of stainless steel <span style="float: right;"><b>new</b></span>	1 unit
60-04-63/001	Set of decalking powder <span style="float: right;"><b>new</b></span>	1 unit = 10 Bags

Height: 2300 mm  
 Width: 2060 mm  
 Depth: 1550 mm

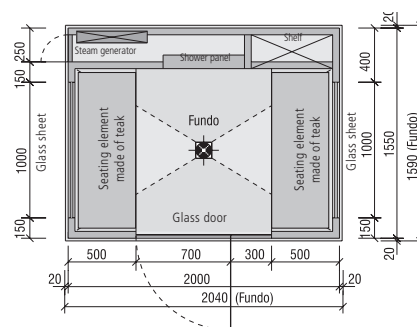
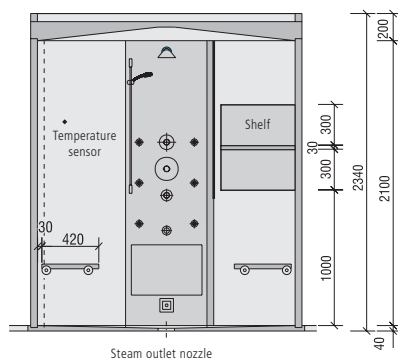

**\*Scope of delivery:**

- Ready-to-install wall and roof elements
- Fundo floor element inc. drain
- Steam technology: steam generator inc. pre-installed pipes
- Shower technology: fully pre-installed pipes for the hand shower
- Massage technology: fully pre-installed pipes for 4 massage nozzles
- 2 seating elements made of teak
- Glass door with metal fittings and door knob
- 2 glass walls including profile system
- 2 halogen lamps and 2 loudspeakers
- Steam outlet nozzle made of aluminium

## wedi Sanoasa Home no. 8, tileable steam shower



Order no.	Description	Packing
07-66-80/000*	Sanoasa Home no. 8	1 unit
07-66-80/110	optional: pre-installed vapour barrier	<b>new</b> 1 unit
07-64-00/106	optional: shower wall panel "deluxe"	1 unit
07-64-00/108	optional: LED technology set of 4 lamps	1 unit
07-64-00/109	optional: fibre glass cable 50 fibres/light points	1 unit
60-05-02/002	optional: cover plate for steam outlet nozzle made of stainless steel	<b>new</b> 1 unit
60-04-63/001	Set of decalking powder	<b>new</b> 1 unit = 10 Bags

Height: 2300 mm  
 Width cabin: 1600 mm  
 Depth cabin: 1500 mm  
 Width roof: 2200 mm  
 Depth roof: 1650 mm

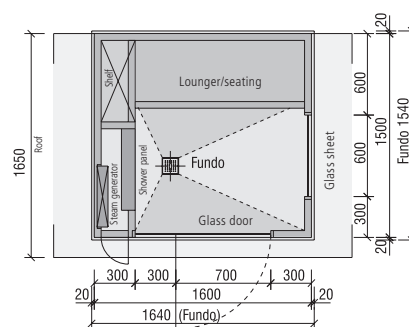
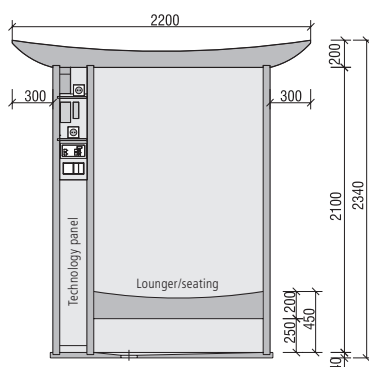

\*Scope of delivery:

- Ready-to-install wall and roof elements
- Fundo floor element inc. drain
- Steam technology: steam generator inc. pre-installed pipes
- Shower technology: fully pre-installed pipes for the hand shower
- Massage technology: fully pre-installed pipes for 4 massage nozzles
- Tileable seating element
- Glass door with metal fittings and door knob
- 1 glass wall including profile system
- 2 halogen lamps and 1 loudspeaker
- Steam outlet nozzle made of aluminium

## wedi Sanoasa Home no. 9, tileable steam shower



Order no.	Description	Packing unit
07-66-90/000*	Sanoasa Home no. 9	1 unit
07-66-90/110	optional: pre-installed vapour barrier	<b>new</b> 1 unit
07-64-00/106	optional: shower wall panel "deluxe"	1 unit
07-64-00/107	optional: LED technology set of 2 lamps	1 unit
07-64-00/109	optional: fibre glass cable 50 fibres/light points	1 unit
60-05-02/002	optional: cover plate for steam outlet nozzle made of stainless steel	<b>new</b> 1 unit
60-05-02/003	optional: cover plate for steam outlet nozzle made of aluminium	<b>new</b> 1 unit
60-04-63/001	Set of decalking powder	<b>new</b> 1 unit = 10 Bags

Height: 2300 mm  
 Width: 1450 mm  
 Depth: 1200 mm

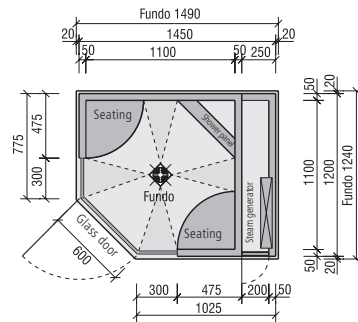
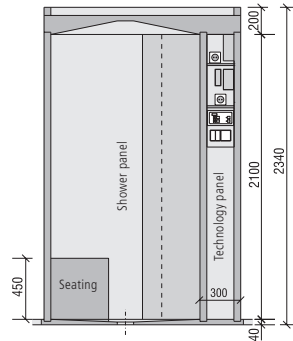

\*Scope of delivery:

- Ready-to-install wall and roof elements
- Fundo floor element inc. drain
- Steam technology: steam generator inc. pre-installed pipes
- Shower technology: fully pre-installed pipes for the hand shower
- Massage technology: fully pre-installed pipes for 4 massage nozzles
- 2 tileable stools
- 1 Glass module inc. profile system, door and metal fittings
- 2 halogen lamps and 1 loudspeaker
- Steam outlet nozzle made of aluminium

## wedi Sanoasa Home no. 10, tileable steam shower



Order no.	Description	Packing
07-67-00/000*	Sanoasa Home no. 10	1 unit
07-66-00/110	optional: pre-installed vapour barrier	<b>new</b> 1 unit
07-64-00/106	optional: shower wall panel "deluxe"	1 unit
07-64-00/108	optional: LED technology set of 4 lamps	1 unit
07-64-00/109	optional: fibre glass cable 50 fibres/light points	1 unit
60-05-02/002	optional: cover plate for steam outlet nozzle made of stainless steel	<b>new</b> 1 unit
60-04-63/001	Set of decalking powder	<b>new</b> 1 unit = 10 Bags

Height: 2300 mm  
 Width: 2060 mm  
 Depth: 1100 mm

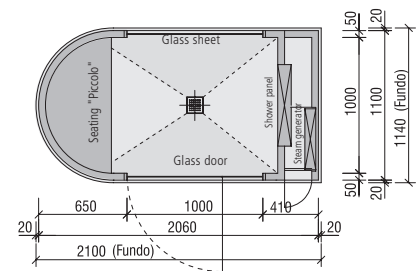
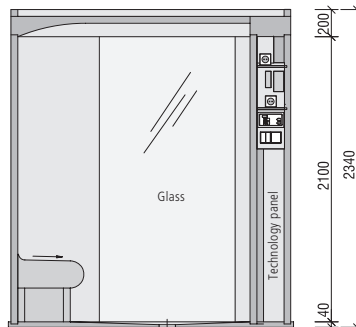

**\*Scope of delivery:**

- Ready-to-install wall and roof elements
- Fundo floor element inc. drain
- Steam technology: steam generator inc. pre-installed pipes
- Shower technology: fully pre-installed pipes for the hand shower
- Massage technology: fully pre-installed pipes for 4 massage nozzles
- Tileable seating element
- Glass door with metal fittings and door knob
- 2 glass wall inc. profile system
- 2 halogen lamps and 2 loudspeakers
- Steam outlet nozzle made of aluminium

**Note:**

Production time for Sanoasa Home: approx. 6-7 weeks after receipt of the order.

## ***Technical advice wedi Sanoasa loungers and seatings***

---

- The standard length of the seating Comodo, the bench Piccolo, the lounge Forma as well as the lounge Collina is 2000 mm.
- Custom made products are quoted according to the project.
- The loungers Corpo and Onda are supplied with rounded edges (D= 100 mm).  
Straight edges can be optionally supplied.
- The lounge Disegno can only be supplied with rectangular sides.
- The choice of the appropriate thermostat for electric heating is to be approved by the Technical Department (phone: +49.2572.1560).  
Thermostats for connection in a technical maintenance room as well as for application onto plaster are available.
- The option of wall and seat heating (Sanoasa Home no. 1-6) consists of pre-installed heating pipes (12 mm PEX) including 1/2 inch threaded connections. The heating technology is to be ordered on site by the customer.
- The hot water heating set and the electric heating set for the bench Piccolo, loungers Forma and Collina are individually quoted according to the project.
- The adhesion of top section and base unit should be done with wedi adhesive and sealing material (order-no.: 07-69-02/000)
- Sanoasa Home no. 1, Sanoasa Home no. 2, Sanoasa Home no. 3, Sanoasa Home no. 4: For steam showers it is advisable to build a slope into the flat roof (condensate conduction).

## wedi Sanbath

### Wash basin wedi Sanbath Wave

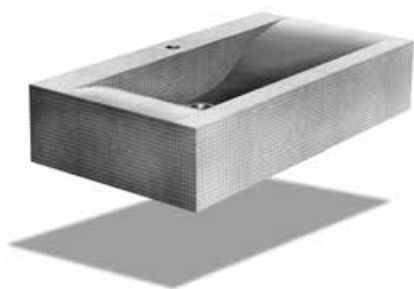

Order no.	Description	Dimensions	Packing
07-36-03/000	wash basin Sanbath Wave including mounting	1000 x 550 x 200 mm	1 unit
07-36-03/500	wash basin Sanbath Wave without mounting	1000 x 550 x 200 mm	1 unit

### Bath tub wedi Sanbath Wave



Order no.	Description	Dimensions	Packing
07-36-01/000	bath tub Sanbath Wave	1800 x 800 x 620 mm	1 unit

### Shower element wedi Sanbath Wave

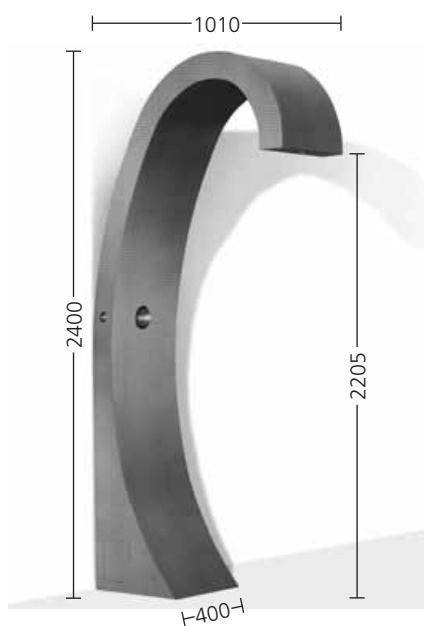

Order no.	Description	Dimensions	Packing
07-36-02/000	shower Sanbath Wave	see diagram	1 unit

### Wash basin wedi Sanbath Flat

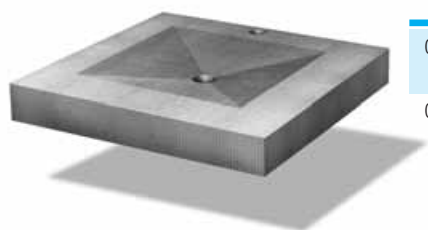

Order no.	Description	Dimensions	Packing
07-36-04/000	wash basin Sanbath flat with mounting	570 x 570 x 80 mm	1 unit
07-36-04/500	wash basin Sanbath flat without mounting	570 x 570 x 80 mm	1 unit

# wedi Sanbath

## Wash stand wedi Sanbath Cube



Order no.	Description	Dimensions	Packing unit
07-36-06/000	wash stand Sanbath Cube	570 x 570 x 925 mm	1 unit

## Bath tub wedi Sanbath Cube



Order no.	Description	Dimensions	Packing unit
07-36-07/000	bath tub Sanbath Cube	1700 x 850 x 600 mm	1 unit

## Shower element wedi Sanbath Cube



Order no.	Description	Dimensions	Packing unit
07-36-05/000	shower element Sanbath Cube	2200 x 400 x 850 x 100 mm	1 unit

### Note:

- The wash basins Sanbath Flat and Sanbath Wave are prepared for the siphon and fittings to be built in.
- The wash stand Sanbath Cube is supplied with a waterproof siphon and prepared to be built in.
- The showers Sanbath Cube and Sanbath Wave are supplied with the I-Box from hansgrohe and pre-fabricated piping for the shower head and hand jet.
- The bath tubs Sanbath Cube and Sanbath Wave are supplied with drainage overflow fittings.



## wedi impact sound deadening boards

### wedi nonstep

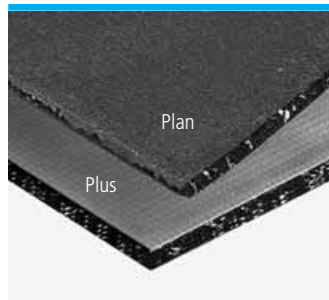

Order no.	Description	Dimensions length x width x height	Packing unit/ pallet
01-12-20/000	nonstep Plan	1200 x 600 x 6 mm	50 boards = 36 m <sup>2</sup>
01-12-00/000	nonstep Plus	1200 x 600 x 12 mm	50 boards = 36 m <sup>2</sup>

## wedi accessory products

### Jolly-Color



Order no.	Description	volume/bottle	Packing unit/ box
06-35-00/*	Jolly-Color	75 ml	6 bottles

#### wedi Jolly-Color is available in the following colours:

add the number of the colour required to the above order number

dark beige	*202	jasmine	*205	manhattan	*210
alpine white	*212	brilliant white	*213	creamy white	*220

It is possible to purchase mixtures of colours within the colour range.

### wedi protective covering fabric



Order no.	Description	Dimensions length x width	Packing unit/ pallet
08-46-00/100	protective covering fabric	25 m x 1000 mm	12 rolls

# PVC profiles

## wedi Jolly-profiles



Order no.	Description	Thickness	Packing unit/ box
05-21-06/**	Jolly-profile	6.0 mm	25 strips/2.5 m each
05-21-08/**	Jolly-profile	8.0 mm	25 strips/2.5 m each
05-21-10/**	Jolly-profile	10.0 mm	25 strips/2.5 m each
05-21-12/*	Jolly-profile	12.5 mm	25 strips/2.5 m each

\*\*article not available in the colour black

## wedi R-profiles



Order no.	Description	Thickness	Packing unit/ box
05-29-06/*	R-profile	6.0 mm	25 strips/2.5 m each
05-29-08/*	R-profile	8.0 mm	25 strips/2.5 m each
05-29-10/*	R-profile	10.0 mm	25 strips/2.5 m each
05-29-12/*	R-profile	12.5 mm	25 strips/2.5 m each

### wedi PVC profiles are available in the following colours:

(add the number of the colour required to the above order number)

grey *201	medium beige *203	jasmine *205	white *206	manhattan *210
brilliant white *213	red *215	blue *216	black *217	creamy white *220

Slight colour variations may occur.

# wedi movement and expansion joints

## wedi Triolos expansion joint profiles



Order no.	Description	Dimensions thickness	Packing unit/ box
05-30-08/*	Triolos expansion joint profile	8.0 mm	25 strips/2.5 m each
05-30-10/*	Triolos expansion joint profile	10.0 mm	25 strips/2.5 m each
05-30-12/*	Triolos expansion joint profile	12.5 mm	25 strips/2.5 m each
05-30-15/*	Triolos expansion joint profile	15.0 mm	25 strips/2.5 m each

### wedi Triolos expansion joint profiles are available in the following colours:

(add the number of the colour required to the above order number)

grey *201	charcoal *218
-----------	---------------

## wedi OK expansion joint profiles – for thin-bed tiling

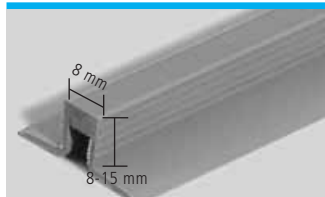

Order no.	Description	Thickness	Packing unit/ box
05-24-18/201	OK expansion joint profile <b>grey</b>	8.0 mm	25 strips/2.5 m each
05-24-20/201	OK expansion joint profile <b>grey</b>	10.0 mm	25 strips/2.5 m each
05-24-22/201	OK expansion joint profile <b>grey</b>	12.5 mm	25 strips/2.5 m each
05-24-25/201	OK expansion joint profile <b>grey</b>	15.0 mm	25 strips/2.5 m each

## wedi OP expansion joint profiles – for thick-bed-tiling



Order no.	Description	Dimensions height x width	Packing unit/ box
05-22-01/**	OP expansion joint profile	40 x 8 mm	100 strips/2.5 m each
05-22-02/**	OP expansion joint profile	40 x 8 mm	50 strips/2.5 m each
05-22-03/*	OP expansion joint profile	26 x 8 mm	50 strips/2.5 m each

### wedi OP expansion joint profile is available in the following colours:

(add the number of the colour required to the above order number)

grey *201	dark beige *202
grey **201	

# Metal profiles

## wedi stepp A.S.S. (stainless steel V4A / satin brushed finish)



Order no.	Description	Thickness	Packing unit/ box
13-73-00/008	stepp A.S.S.	8.0 mm	20 strips / 2.5 m each
13-73-00/010	stepp A.S.S.	10.0 mm	20 strips / 2.5 m each
13-73-00/012	stepp A.S.S.	12.5 mm	20 strips / 2.5 m each
13-73-00/015	stepp A.S.S.	15.0 mm	20 strips / 2.5 m each

## wedi brass profiles



Order no.	Description	Thickness	Packing unit/ box
10-56-10/006	brass profile	6.0 mm	40 strips / 3.0 m each
10-56-10/008	brass profile	8.0 mm	40 strips / 3.0 m each
10-56-10/010	brass profile	10.0 mm	40 strips / 3.0 m each
10-56-10/012	brass profile	12.5 mm	40 strips / 3.0 m each
10-56-10/015	brass profile	15.0 mm	40 strips / 3.0 m each
10-56-10/017	brass profile	17.5 mm	40 strips / 3.0 m each
10-56-10/020	brass profile	20.0 mm	40 strips / 3.0 m each

Order no.	Description	Thickness	Packing unit/ box
10-56-11/006	brass profile	6.0 mm	40 strips / 1.0 m each
10-56-11/008	brass profile	8.0 mm	40 strips / 1.0 m each
10-56-11/010	brass profile	10.0 mm	40 strips / 1.0 m each
10-56-11/012	brass profile	12.5 mm	40 strips / 1.0 m each
10-56-11/015	brass profile	15.0 mm	40 strips / 1.0 m each

## wedi aluminium profiles



Order no.	Description	Thickness	Packing unit/ box
10-57-10/006	aluminium profile	6.0 mm	40 strips / 3.0 m each
10-57-10/008	aluminium profile	8.0 mm	40 strips / 3.0 m each
10-57-10/010	aluminium profile	10.0 mm	40 strips / 3.0 m each
10-57-10/012	aluminium profile	12.5 mm	40 strips / 3.0 m each

Order no.	Description	Thickness	Packing unit/ box
10-57-11/006	aluminium profile	6.0 mm	40 strips / 1.0 m each
10-57-11/008	aluminium profile	8.0 mm	40 strips / 1.0 m each
10-57-11/010	aluminium profile	10.0 mm	40 strips / 1.0 m each
10-57-11/012	aluminium profile	12.5 mm	40 strips / 1.0 m each

### wedi stainless steel V<sub>4</sub>A profiles / satin brushed finish



Order no.	Description	Thickness	Packing unit/ box
13-72-00/006	stainless steel V <sub>4</sub> A profile	6.0 mm	40 strips / 3.0 m each
13-72-00/008	stainless steel V <sub>4</sub> A profile	8.0 mm	40 strips / 3.0 m each
13-72-00/010	stainless steel V <sub>4</sub> A profile	10.0 mm	40 strips / 3.0 m each
13-72-00/012	stainless steel V <sub>4</sub> A profile	12.5 mm	40 strips / 3.0 m each
13-72-00/015	stainless steel V <sub>4</sub> A profile	15.0 mm	40 strips / 3.0 m each

Order no.	Description	Thickness	Packing unit/ box
13-72-10/006	stainless steel V <sub>4</sub> A profile	6.0 mm	40 strips / 1.0 m each
13-72-10/008	stainless steel V <sub>4</sub> A profile	8.0 mm	40 strips / 1.0 m each
13-72-10/010	stainless steel V <sub>4</sub> A profile	10.0 mm	40 strips / 1.0 m each
13-72-10/012	stainless steel V <sub>4</sub> A profile	12.5 mm	40 strips / 1.0 m each
13-72-10/015	stainless steel V <sub>4</sub> A profile	15.0 mm	40 strips / 1.0 m each

### wedi stainless steel edge protection profile V<sub>4</sub>A satin brushed finish

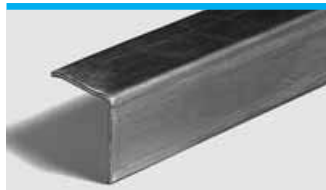

Order no.	Description	Dimensions/ flange	Packing unit/ box
13-74-00/120	stainless steel V <sub>4</sub> A edge protection profile	30 x 30 mm	25 strips / 2.0 m each

### wedi VIP profiles V<sub>2</sub>A – bright polished finish



Order no.	Description	Thickness	Packing unit/ box
13-76-00/006	VIP profile	6.0 mm	10 strips / 2.5 m each
13-76-00/008	VIP profile	8.0 mm	10 strips / 2.5 m each
13-76-00/010	VIP profile	10.0 mm	10 strips / 2.5 m each
13-76-00/012	VIP profile	12.5 mm	10 strips / 2.5 m each

### wedi VIP-profiles V<sub>2</sub>A / flat rolled finish



Order no.	Description	Thickness	Packing unit/ box
13-76-10/006	VIP profile	6.0 mm	20 strips / 2.5 m each
13-76-10/008	VIP profile	8.0 mm	20 strips / 2.5 m each
13-76-10/010	VIP profile	10.0 mm	20 strips / 2.5 m each
13-76-10/012	VIP profile	12.5 mm	20 strips / 2.5 m each

### wedi VIP-corner V<sub>2</sub>A / polished finish



Order no.	Description	Thickness	Packing unit/ blister
13-76-15/006	VIP-corner	6.0 mm	1 blister x 2 corners
13-76-15/008	VIP-corner	8.0 mm	1 blister x 2 corners
13-76-15/010	VIP-corner	10.0 mm	1 blister x 2 corners
13-76-15/012	VIP-corner	12.5 mm	1 blister x 2 corners

### wedi Combi-profile V<sub>4</sub>A / flat rolled finish



Order no.	Description	Thickness	Packing unit/ box
13-78-05/008	Combi-profile	8.0 mm	10 strips / 2.5 m each
13-78-05/010	Combi-profile	10.0 mm	10 strips / 2.5 m each
13-78-05/012	Combi-profile	12.5 mm	10 strips / 2.5 m each
13-78-10/008	Combi-profile	8.0 mm	10 strips / 1.0 m each
13-78-10/010	Combi-profile	10.0 mm	10 strips / 1.0 m each
13-78-10/012	Combi-profile	12.5 mm	10 strips / 1.0 m each

**wedi PRO Balco EKL V<sub>4</sub>A – satin brushed finish**

Order no.	Description	Thickness	Packing unit/ box
13-77-00/030	PRO Balco EKL 30	30 mm	5 strips / 2.5 m each
13-77-00/040	PRO Balco EKL 40	40 mm	5 strips / 2.5 m each
13-77-00/060	PRO Balco EKL 60	60 mm	5 strips / 2.5 m each
13-77-00/096	PRO Balco EKL 90	90 mm	5 strips / 2.5 m each

**wedi PRO Balco EKL-connector V<sub>4</sub>A – satin brushed finish**

Order no.	Description	Thickness	Packing unit/ box
13-77-05/030	PRO Balco EKL-connector 30	30 mm	10 pieces
13-77-05/040	PRO Balco EKL-connector 40	40 mm	10 pieces
13-77-05/060	PRO Balco EKL-connector 60	60 mm	10 pieces
13-77-05/096	PRO Balco EKL-connector 90	90 mm	10 pieces

**wedi PRO Balco EDB V<sub>4</sub>A – satin brushed finish**

Order no.	Description	Thickness	Packing unit/ pallet
13-77-10/060	PRO Balco EDB 60	60 mm	5 strips / 2.5 m each

**wedi PRO Balco EDB connector V<sub>4</sub>A – satin brushed finish**

Order no.	Description	Thickness	Packing unit/ box
13-77-11/060	PRO Balco EDB connector	60 mm	10 pieces

**wedi PRO Balco EDB corner piece V<sub>4</sub>A – satin brushed finish**

Order no.	Description	Thickness	Packing unit/ box
13-77-12/060	PRO Balco EDB corner	60 mm	10 pieces



## Notes

---



**wedi**<sup>®</sup>

**wedi GmbH**

Kolpingstraße 52-54 · D-48282 Emsdetten  
Postbox 11 39 · D-48269 Emsdetten  
Telefon +49 2572 156-0 · Fax +49 2572 156-133  
Internet: [www.wedi.de](http://www.wedi.de) · E-Mail: [info@wedi.de](mailto:info@wedi.de)